

Legrand Product Basket -2015

Legrand Product Segment

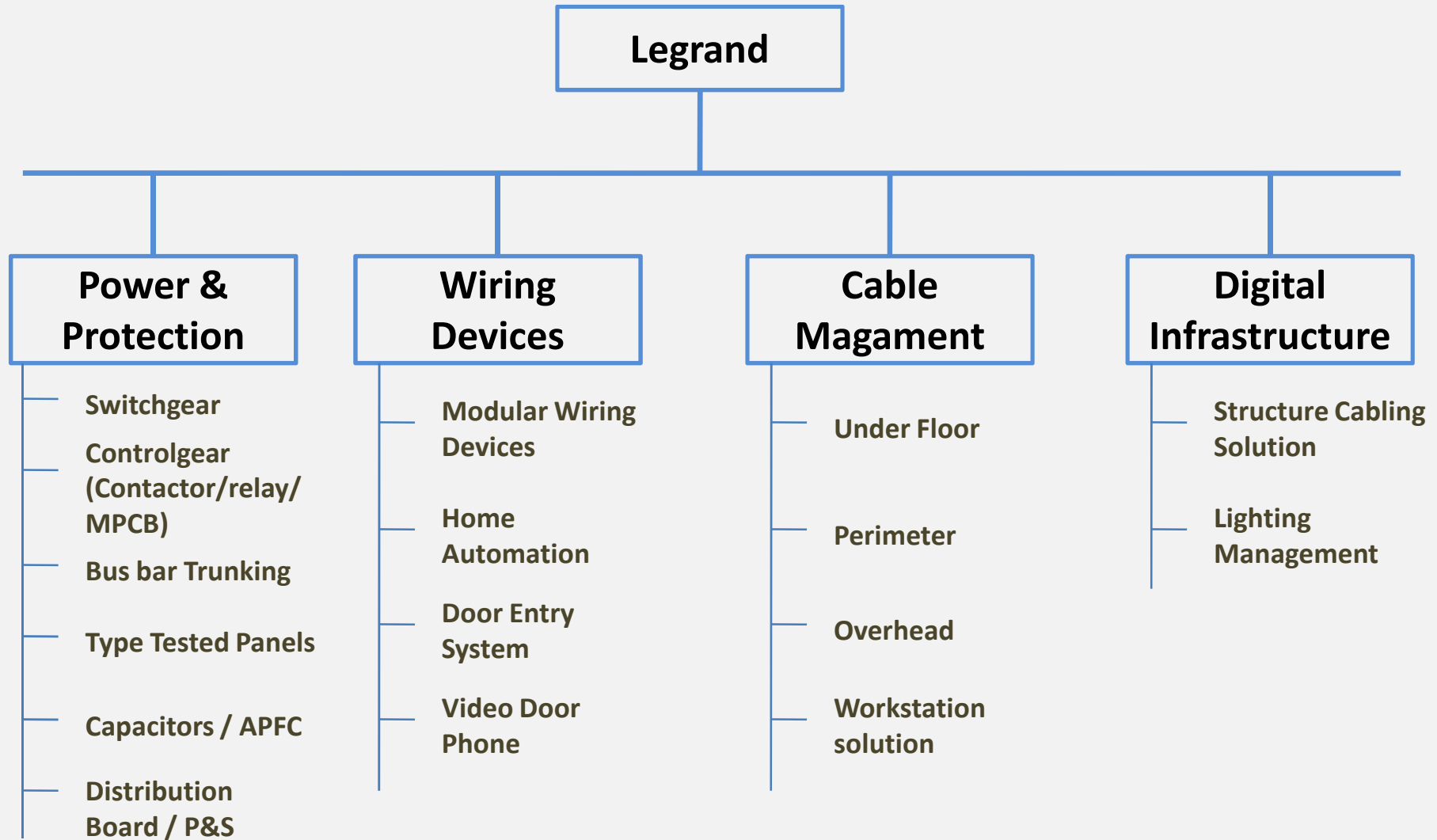

Legrand Product Segment

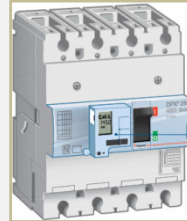

Power / Protection

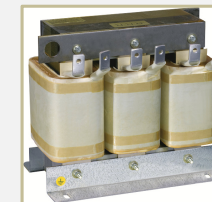

Air Circuit Breaker



RANGE – DMX3

BREAKER

RATING – 630A to 6300A
BREAKING CAPACITY – 50kA, 65kA, 100kA
TYPE – FIXED / DRAWOUT
FRAME – FRAME 1 (630A – 2500A)
 FRAME 2 (3200A – 4000A)
 FRAME 3 (5000A – 6300A)



RELEASE

RANGE – MP4 & MP6
TYPE – LSI / LSIg

Key Features

- LCD Screen present even on the base level breaker
- Simpler cabling using the Cage clamps
- Visualisation of auxiliaries
- Battery for the Protection unit
- Logic selectivity with DPX MCCBs
- Service continuity – using the mechanical interlock (cable) and Electronic control box

Molded Case Circuit Breakers (MCCB)

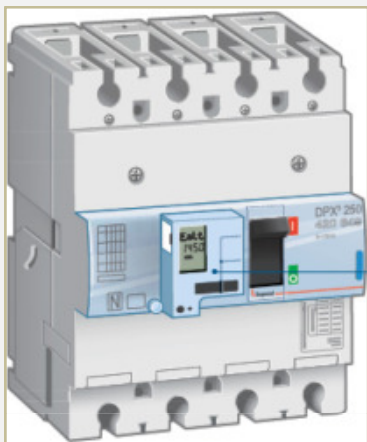

RANGE – DPX / DPX3

RATING – 16A to 1600A

BREAKING CAPACITY – 16kA, 25kA, 36kA, 50kA, 70kA

TYPE – Thermal Magnetic / Microprocessor Release

SIZE – DPX³ 160 (16A to 160A)

DPX³ 250 (100A to 250A) / DPX 250 (40A to 250A)

DPX 630 (250A to 630A)

DPX 1250 / 1600 (800A to 1600A)

Key Benefits

- Display in DPX3 Range
- RS 485 Communication
- Visualisation of auxiliaries
- Metering module built in

Miniature Circuit Breaker (MCB)

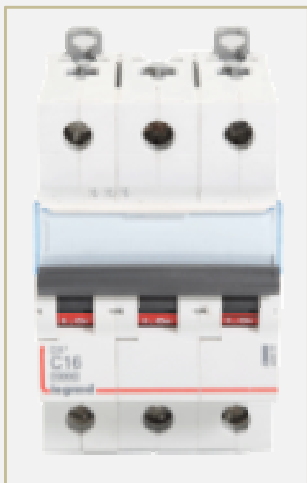

RANGE – DX3

RATING – 0.5A to 125A

BREAKING CAPACITY – 10kA, 16kA, 25kA, 36kA, 50kA

TYPE – Thermal Magnetic

SIZE – 0.5A to 62A (1pole = 1Module) (16kA)

80 to 125A (1Pole = 1.5Module) (16kA)

For 25kA, 36kA, 50kA (1Pole = 1.5Module)

Key Benefits

- International range with 13 new features.
- Complete range of Auxiliaries, RCD & Timers.
- Available in both C & D Curve
- Plug in type Solution available.

Power Contactor / Thermal Overload Relays



RANGE – CTX3

Contactor

RATING – 6A to 900A
3P – 22Reference AC-3 Type
4P – 12Reference AC-1 Type



RANGE – RTX3

TM O/L RELAY

RATING – 0.1A to 800A
Tripping Class 10A

Key Features

- Small size
- Low consumption
- Accessories: interlock unit, thermal overload relays, auxiliary contacts

Motor Protector Circuit Breaker (MPCB)



RANGE – MPX3

BREAKER

RATING – 0.16A to 100A

BREAKING CAPACITY – Standard & High
22 Ratings

Key Features

- Overload tripping class 10
- Phase failure protection
- Utilization category
- IEC/EN 60947-2 (breaker) Cat.A
- IEC/EN 60947-4 (starter) AC 3
- Instantaneous short circuit release 13xI_e max

Distribution Board



RANGE – Ekinoxe

RATING – SPN, ETPN, VTPN, 7 Segment, Flexy, P&S.

TYPE – Metal DB

PROTECTION – IP 20, 43, 54

SIZE – SPN (4,8,12,16 Way)

TPN (4,6,8,12,16 Way)

7 Segment (4, 6, 8, 13 Way)

VTPN (4, 8, 12 Way)

Flexy DB (13Module 2,3,4 Row)



RANGE – Plexo³

RATING – SPN, ETPN, VTPN, 7 Segment, Flexy, P&S.

TYPE – Metal DB

PROTECTION – IP 66

SIZE – SPN (2, 4, 6, 12 Module)

SPN (12Module 2,3,4 Row)

SPN (18Module 2,3,4 Row)

Industrial Plug & Socket Solution



- P17 tempra
 - 16 A to 125 A



- Hypra
 - 16 A to 125 A



- Prisinter
 - 16A -32 A - 63 A



- Combined unit

Combined Unit Plug & Socket Solution

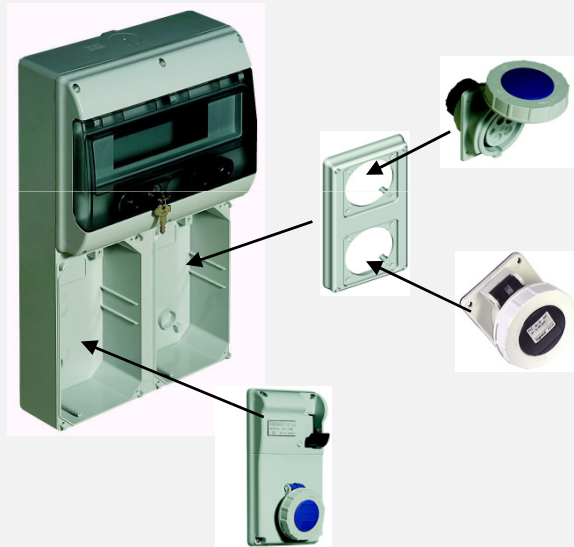

Possible combinations with bases for 220 x 125 mm faceplates								
Cat.No	Nb of sockets	Intensity			Number of faceplates			
		16 A	16 A or 32 A	63 A	0577 12	0577 13	0577 17	
With box or base								
0577 10 or 0589 38	1 socket	-	1	-	1	-	-	
	2 sockets	2	-	-	-	1	-	
0577 05	2 sockets	-	2	-	2	-	-	
		-	1	1	1	-	1	
	-	-	2	-	-	-	2	
	3 sockets	3	-	-	1	1	-	
		2	1	-	1	1	-	
4 sockets	2	-	1	-	-	1	1	
	4	-	-	-	-	2	-	
0577 06	3 sockets	-	3	-	3	-	-	
		-	-	3	-	-	3	
		-	1	2	1	-	2	
	4 sockets	-	2	1	2	2	-	1
		2	1	1	1	1	1	1
		2	2	-	2	1	-	
	5 sockets	2	-	2	-	1	2	
		4	1	-	1	2	-	
	6 sockets	4	-	1	-	2	1	
		6	-	-	-	3	-	

Busbar Trunking System

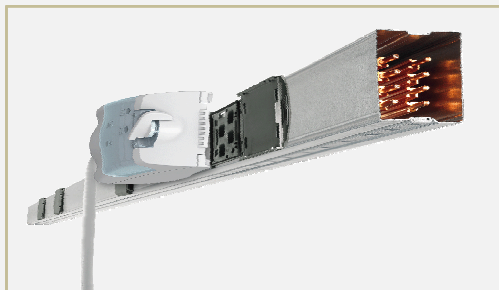

RANGE – Zucchini

RATING – 25A to 5000A

TYPE – Air Insulated / Sandwich

Material – Aluminum / Copper

PROTECTION – IP 55



Configuration – 4Conductor / 5Conductor

SIZE – LB Plus (25A, 40A, 63A Air Insulated)

MS (63A, 100A , 160A Air Insulated)

MR (160A to 1000A Air Insulated)

SCP (630A to 5000A Sandwich Type)



Type Tested Panels



XL³

Key Features

- Completely bolted
- Totally type-tested system as per IEC 61439-I
- Completely bolted system for ease of assembly
- Modular design for numerous configurations
- Short time current withstand capacity upto 110 kA
- Design suitable for Form 4b
- IP 55 degree of protection also available
- Fire resistance of 7500C for 30 sec
- Compatible with Zucchini busbar trunking system
- Adjustable plinth height for the better spreading of cables
- Permanent earthing for internal components and external faceplates
- Perfectly house the whole range of Legrand ACBs, MCCBs, Capacitors, MCBs, Metering devices and OMPs like VSP, MPCB etc.

Capacitors / APFC



CAPACITOR RANGE

Alpican

1 to 30 KVAR
Resin filled & Gas filled
Standard duty & Heavy duty

Alpivar 2

1 to 125 KVAR

Reactor

10 to 100 KVAR

Automatic power factor controller

3, 5, 7 & 12 steps



Legrand Product Segment



Wiring Devices

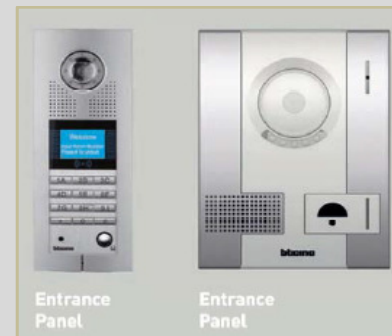

Modular Switches



ARTEOR™



ARTEOR™ FLOW OF ENERGIES

With a wide range of ergonomics and finishes to satisfy the most demanding customers, it's minimalist and bevelled design is inspired by the most modern technological devices such as flat screens or digital photo frames, creating the impression that the device is floating on the wall. Arteor suits any requirement in terms of design and function for every kind of building from residential to commercial.

Modular Switches





ANTI-BACTERIAL

Ag+ ions eliminates the proliferation of bacteria on contact and the smooth design facilitates in reducing dust accumulation. Ideal for agri-food premises and health-care environments



Myrius™ More is on

Simple, Sleek and smooth, Myrius with it's curved edges gives it a distinct and appealing look. Moreover, its minimalistic design makes it look absolutely stunning and desirable. But what makes Myrius truly beautiful is a classic black and white shade that offers an aura of comfort and timelessness.

Modular Switches



Mylinc™

A little touch of genius

Mylinc™ reveals smartness in modular switches. The Mylinc range incorporates elements of smart design in the minutest of details. Like screwless finish, alignment perfection and various aspect of safety, reliability and convenience.

Home Automation Solution

ARTEOR™ FLOW OF ENERGIES

User requirements in terms of home automation are continually rising. To meet these expectations, Legrand has developed a dual response: a Plug & Play solution with radiofrequency technology based on ZigBee® protocol, and a BUS/SCS offer providing the fully-integrated solution package. These two technologies can cross-communicate via a shared platform.



Door Entry Solution – D-45

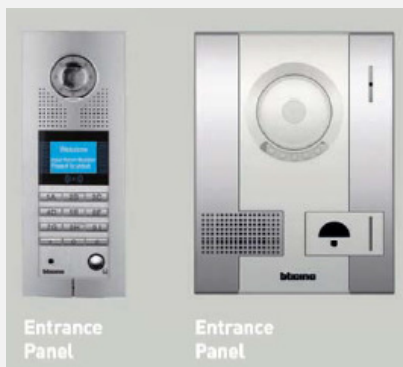

D45 SYSTEM

HIGH PERFORMANCE DOOR ENTRY SYSTEM

Elegant design encased in a slim and compact shape, it performs multi functions like call, doorbell, conversation, monitor, unlock, network and alarms, by connecting riser systems to system network devices. The range has innovative functions like SOS pushbutton, anti-tamper function and intercom between all riser apartments.

Video Door Phones



RANGE

VIDEO DOOR PHONE KIT

- Colour 7Inch & 5.3Inch Option
- Handset & Hands free Operation
- Maximum 3 indoor Unit
- Intercom bbetween indoor units
- Door unlock function from indoor unit
- IP-55 Out door unit.
- LED light in outdoor unit for low light application.

Legrand Product Segment



Cable Management Solution



Under Floor Solution

Metal Raceways (GI)- Range 38 & 25 mm

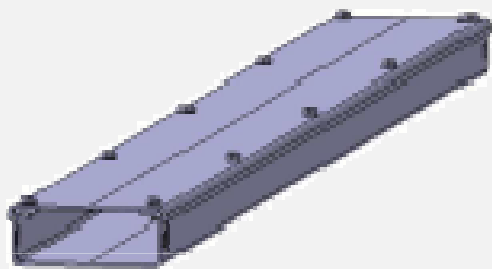

GI Raceways 38 & 25 mm - One Compartment

- 50 mm width
- 75 mm width
- 100 mm width
- 150 mm width

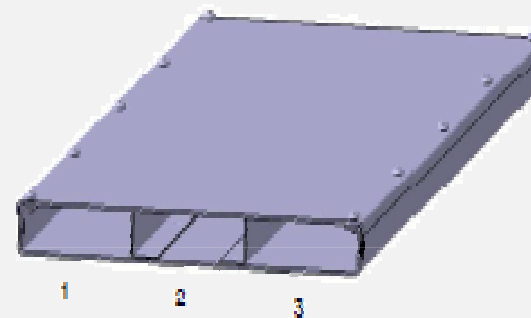

GI Raceways 38 & 25 mm - Three Compartment

- 225 mm width
- 300 mm width

Under Floor Solution

PVC Raceways –
Range with height 38 mm

PVC Raceways 38 mm

- 50 mm width with one Compartment
- 100 mm width with 2 Compartment
- 150 mm width with 3 Compartment



Under Floor Solution

PVC Raceways – Range with Height 25 mm

PVC Raceways 25 mm

- 75 mm width with one compartment
- 225 mm width with 3 compartment
- Option to attach compartment of 75mm on both the above raceways



Under Floor Solution

Height Adjustable Junction Box - Range

Junction Box without Flyover

- JB 150x150
- JB 225x225
- JB 300x300
- JB 400x400

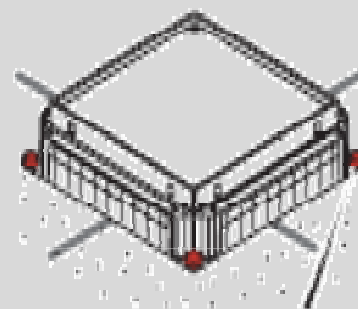

Junction Box with Flyover

- JB 225x225
- JB 300x300
- JB 400x400

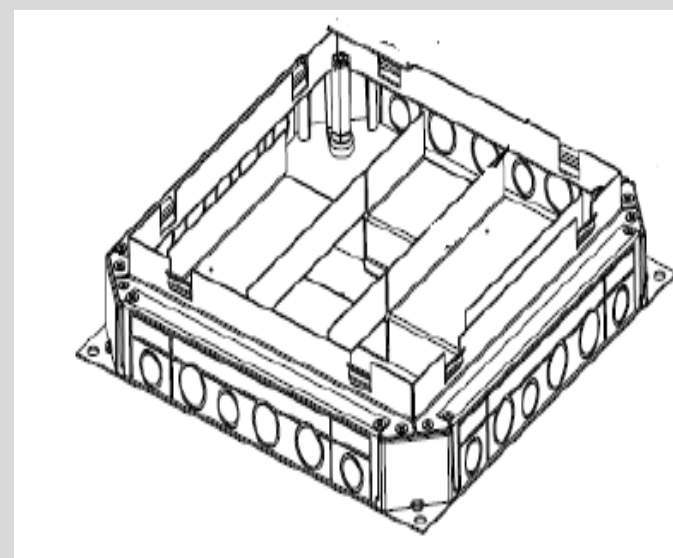

Under Floor Solution



Floor Box Solution

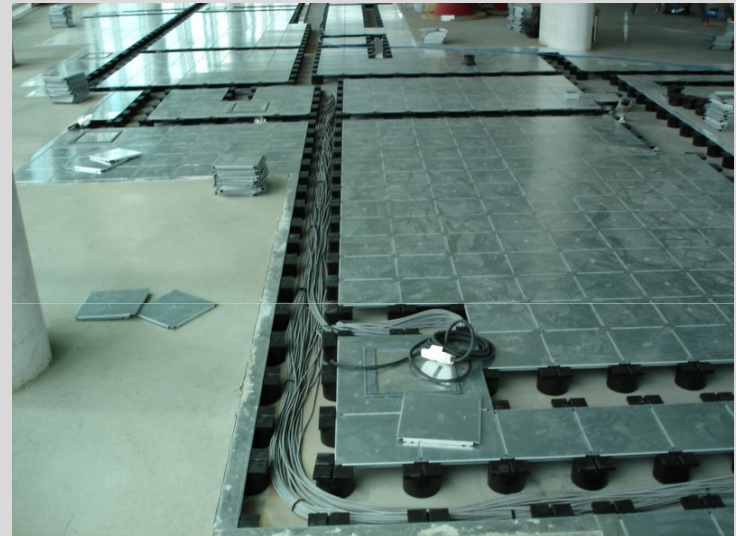

Raised Floor Solution

Perimeter Solution



Snap on PVC Trunking



DLP PVC Trunking



Snap on Columns

Overhead Solution

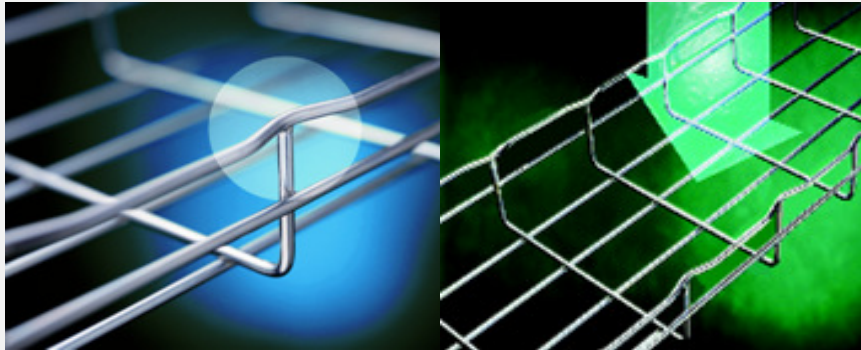

Increase contractor productivity, reduce installation costs – with Cablofil. Be it above the ceiling, on the wall, or under the floor, our components make any installation a snap. Our wire mesh cable tray creates neat and orderly pathways, ideal for open installations. All reasons why customers prefer Cablofil the most sought after brand of wire mesh cable tray in the world!

[CABLOFIL VIDEO](#)

Workstation Solution



Pop Up Box



Desk Grommet



Desk Extension Module



Power & Data Strip

Legrand Product Segment

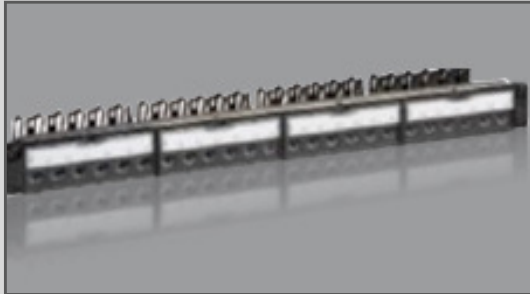

Digital Infrastructure



Passive Networking Solution



LEGRAND CABLING SYSTEM²

Performance from the technical room to the workstation

Legrand Cabling System² offers high performance connectivity solutions in Copper, Fiber, Wi-Fi and enclosures for multimedia environments. Additional benefits: the perfect synergy with other Legrand products and solutions such as cable management, trunking system, wiring devices etc. Legrand solutions allow to create coherent and efficient systems from the technical room through to the workstations.

Lighting Management Solution



Energy saving



Economic saving



Code compliance



Sustainability building practice



LIGHTING MANAGEMENT

Legrand provides products that make buildings more energy efficient. Legrand is committed to 'putting a stop to energy waste'. Lighting is a significant consumer of energy in commercial sector. It consumes up to 40% of the total electricity in commercial building.* Each year, more organisations implement lighting management because they recognize the benefit of power saving.

THANK YOU